

# Paper Model Quasi-Zenith Satellite-1(QZS-1) to QZS-4 "MICHIBIKI"



[What you need]

- Wood glue ● Toothpick

[Cautions]

- Cut the parts along the perforation.
- Fold along the mountain and valley fold lines according to the instructions.
- Assemble in order according to the symbols ( ● ▲ ■ )

[Line types]

- Mountain fold
- Valley fold
- Glue margin
- Guide line

[Choosing a satellite]

Which one will you pick?

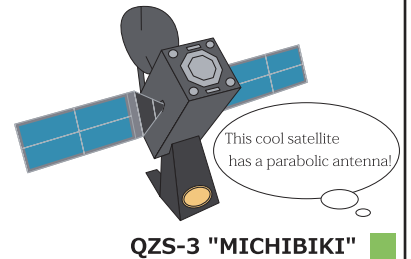
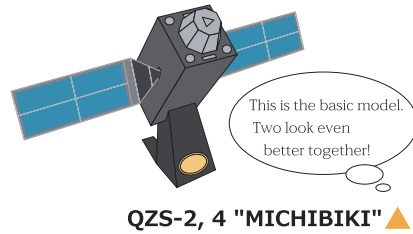
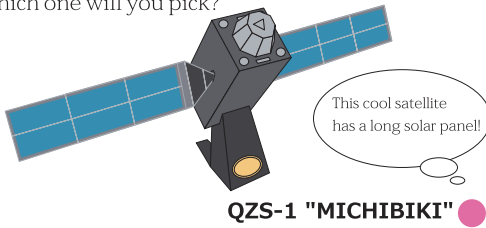

1 Assemble the solar panel ● ▲ ■

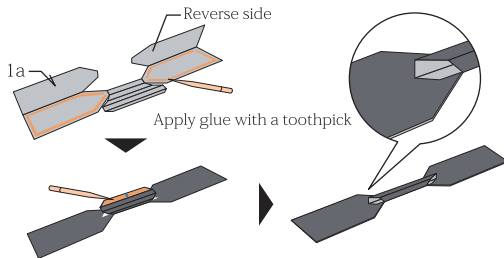

2 Assemble the main satellite unit ● ▲ ■

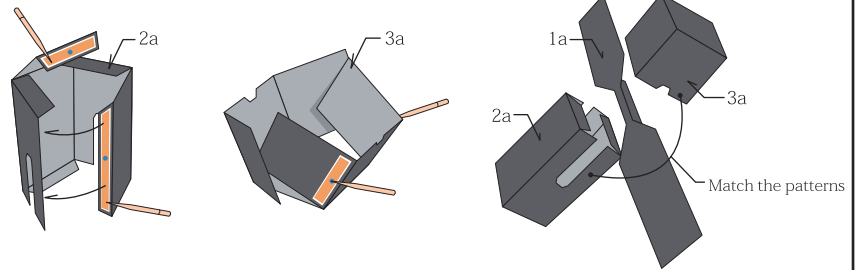

3 Other parts

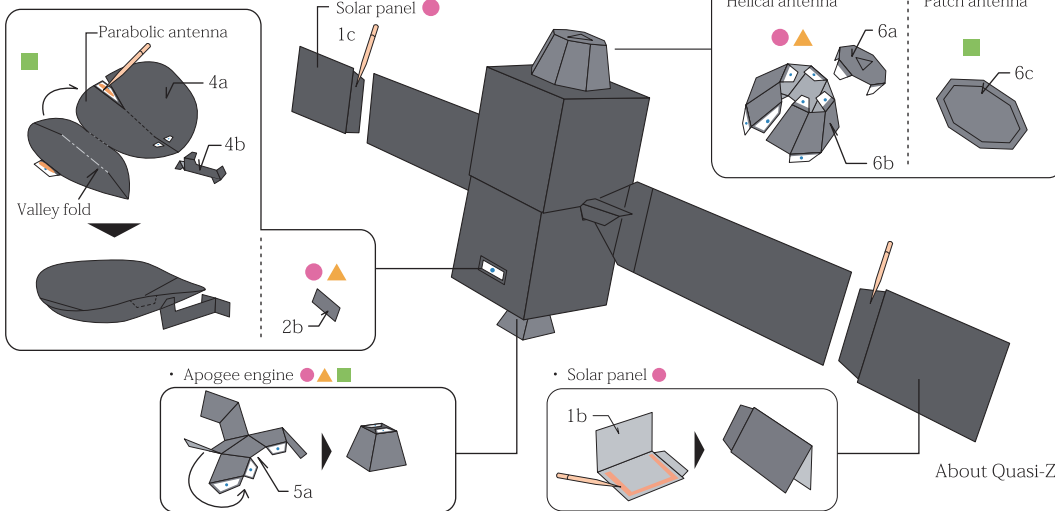

4 Assemble the stand ● ▲ ■

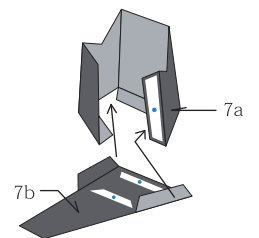

Set up the stand according to the illustrations of the three completed satellites.

About Quasi-Zenith Satellite "MICHIBIKI"  
<http://qzss.go.jp/en/>

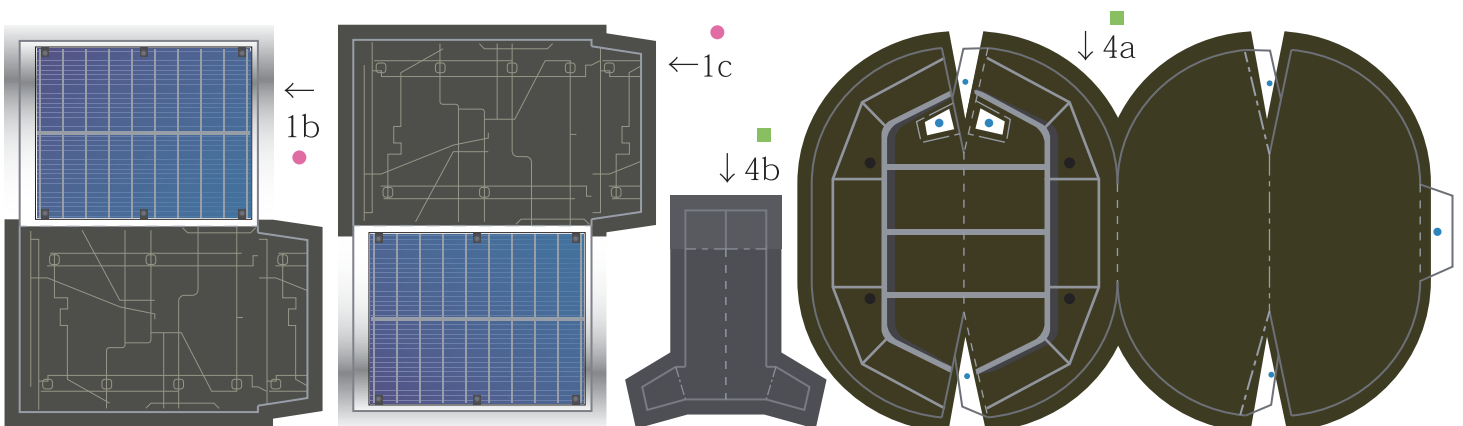

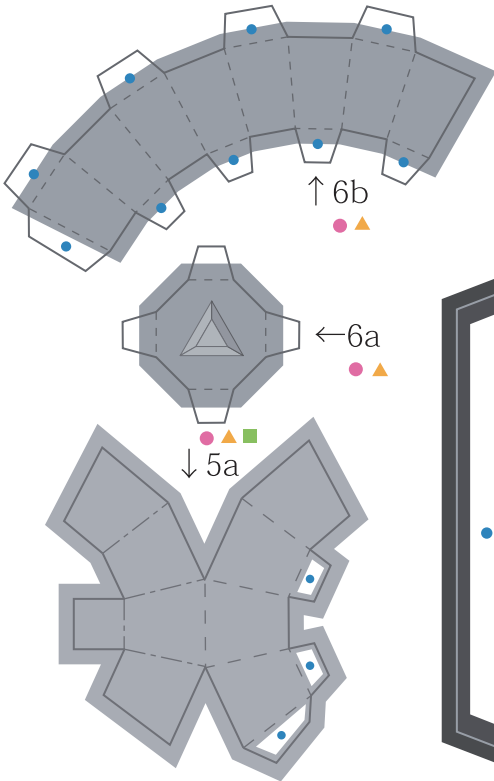
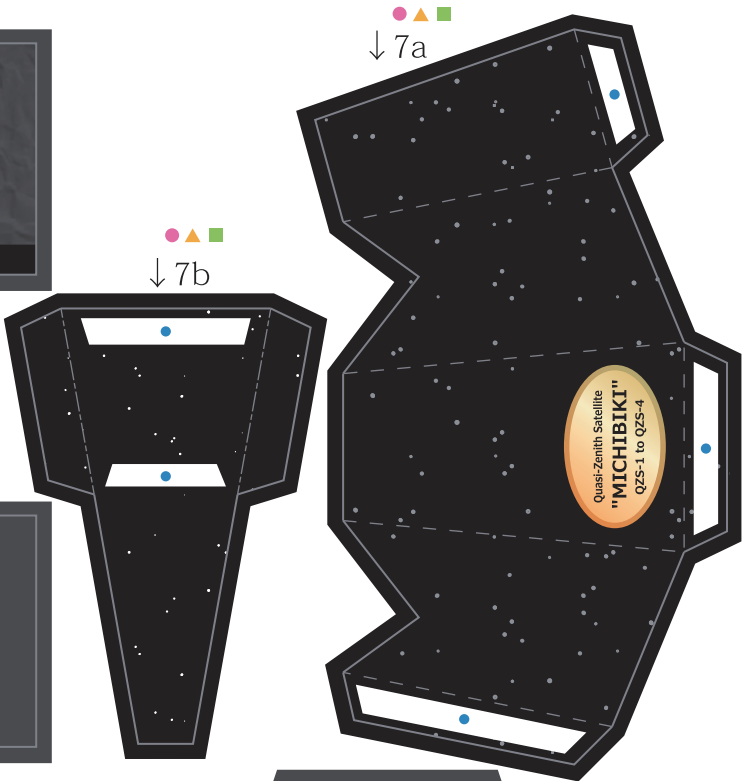
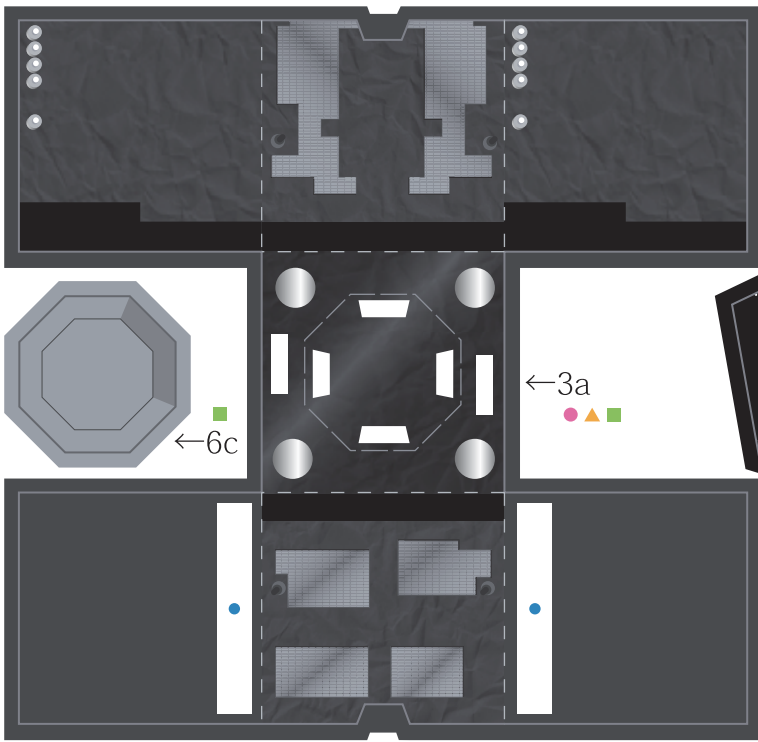

- Mountain fold
- Valley fold
- Glue margin
- Guide line

